

Guidelines for the

SAFE HANDLING, TRANSPORTATION and STACKING of LARGE HAY BALES



ACKNOWLEDGEMENTS

This booklet draws on information from the Health and Safety Executive publication *Handling and Stacking Bales in Agriculture* and from Occupational Safety and Health Service (OSH) inspectors' accident reports.

OSH also records its thanks to Pearson Engineering Ltd., Matamata; Fairbrother Industries Ltd., Auckland; and Federated Farmers NZ Inc., Taranaki Division.

Published by the Occupational Safety and Health Service
Department of Labour
Wellington
New Zealand

First Edition: September 1995

ISBN 0-477-03570-1

CONTENTS

FOREWORD BY FEDERATED FARMERS	5
FOREWORD BY OSH	6
INTRODUCTION	7
1. ASSESS THE HAZARDS	8
2. CHILD SAFETY	10
3.EMPLOYEE SAFETY	11
4. OVERHEAD POWER LINES	12
5. USE THE PROPER EQUIPMENT	15
6. OTHERS MATTERS TO CHECK	19
7. TRANSPORTING BALES	21
8. SAFE STACKING	22
9. DESTACKING	26
10. MAINTENANCE OF STACKS	27
11. SAFETY WITH TRAILERS	28
12. ROPING AND SHEETING	30
13. WORKING AT HEIGHTS	31
14. ACCIDENT CASE HISTORIES	33
15. BASIC SAFETY RULES	38
APPENDIX: SUMMARY OF LEGAL OBLIGATIONS UNDER THE HEALTH AND SAFETY IN EMPLOYMENT ACT	39
WHERE TO GET FURTHER ADVICE	44

SPECIAL NOTE ON SAFETY DEVICES

At the time of writing, Federated Farmers Mid-Canterbury Division is considering a project to explore the feasibility of safety devices being fitted to tractor safety frames to protect the drivers of tractors fitted with two-post safety frames.

Should the project proceed, information on any safety devices developed will be included in subsequent issues of this guide.

FOREWORD BY FEDERATED FARMERS

Transporting and stacking large hay bales has, over recent years, resulted in numerous injuries to and deaths of some operators of the machinery or people near the scene of operations.

Many of these accidents could have been prevented had equipment more suited to the job been used, and more care taken by the operators when using the equipment.

To try to reduce the number of future mishaps, Federated Farmers has joined with OSH in producing these guidelines to the safer handling of large bales.

The Health and Safety in Employment Act requires you to operate a safe workplace. Using inappropriate equipment would not be regarded as operating a safe workplace.

Remember, the bales are bigger than you are — they won't give you a second chance to get out of their way.

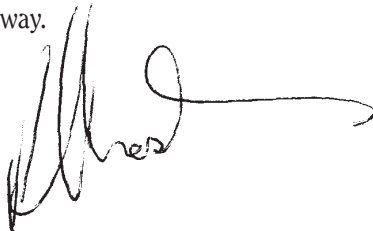

Mark Masters

Federated Farmers of New Zealand (Inc).

FOREWORD BY OSH

The Department of Labour's Occupational Safety and Health Service (OSH) has for many years been concerned with the suffering, harm and loss of life caused by accidents associated with the transportation and stacking of large hay bales.

This guide contains practical methods of carrying out this work. Adopting the safe work practices in this guide will help you to meet your obligations under the Health and Safety in Employment Act 1992.



R. J. M. Hill
General Manager
Occupational Safety and Health Service

INTRODUCTION

This booklet gives safety advice to everyone involved in the handling, transportation and stacking of large hay bales. It deals with round and square bales. It does not cover baling or wrapping.

The booklet will help you to identify the hazards in the job and take the necessary precautions and control measures so that accidents can be avoided, both to yourself and to other people.

Although it deals with hay bales, you need to take extreme care when using machinery to lift other objects or materials, such as logs. Whatever the job, using the right equipment and methods is essential.

Employers, the self-employed, employees and contractors need to be aware of their legal obligations under the Health and Safety in Employment Act 1992. A summary of these obligations is contained in the appendix to this guide.

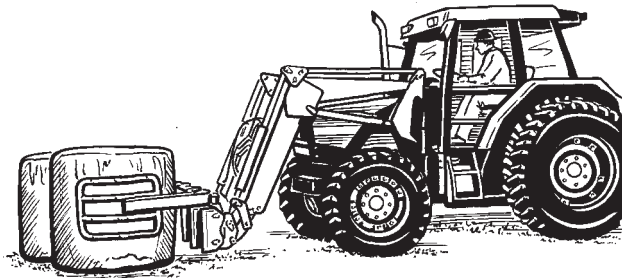

1. ASSESS THE HAZARDS

All work activities involving bale transportation, stacking and handling need to be assessed to ascertain the hazards and the steps needed to protect those involved from the hazards. This applies whether you are an employer, self-employed, a contractor or a person in control. When assessing hazards, don't overlook the risks to your family and members of the public as well as to yourself and your employees.

A simple checklist to help you assess the hazards is given on the facing page. It may be expanded on or you may develop your own.

SAFETY CHECKLIST BEFORE STARTING WORK

ITEM	CHECK	Yes	No
Children	Kept clear	<input type="checkbox"/>	<input type="checkbox"/>
	Supervised	<input type="checkbox"/>	<input type="checkbox"/>
Employees	Properly trained	<input type="checkbox"/>	<input type="checkbox"/>
	Aware of dangers/precautions	<input type="checkbox"/>	<input type="checkbox"/>
	Medically and physically fit for tasks	<input type="checkbox"/>	<input type="checkbox"/>
Environment	Suitable for stacking/work to be done	<input type="checkbox"/>	<input type="checkbox"/>
	Free from holes, ditches, etc.	<input type="checkbox"/>	<input type="checkbox"/>
	Away from overhead power lines	<input type="checkbox"/>	<input type="checkbox"/>
Handling equipment	Hydraulic hoses secure	<input type="checkbox"/>	<input type="checkbox"/>
	Hoses free from leaks	<input type="checkbox"/>	<input type="checkbox"/>
	Equipment securely fitted to tractor	<input type="checkbox"/>	<input type="checkbox"/>
	Equipment moving/operating freely	<input type="checkbox"/>	<input type="checkbox"/>
	Correct equipment used	<input type="checkbox"/>	<input type="checkbox"/>
	Tractor safety frame fitted	<input type="checkbox"/>	<input type="checkbox"/>
	Power controls in order	<input type="checkbox"/>	<input type="checkbox"/>
	Handling equipment controls in order	<input type="checkbox"/>	<input type="checkbox"/>

2. CHILD SAFETY

Children are particularly at risk when farm machinery is in use. Follow these safety rules:

- Keep children well away from bale stacks and handling and stacking operations.
- Supervise young children.
- Don't allow children under the age of 15 years to assist with, adjust or clean any machinery.
- Don't allow children under the age of 15 years to drive a tractor, ride on a tractor when it is towing an implement, or ride on any implement.

CHILDREN ON TRACTORS: SPECIAL CIRCUMSTANCES

Children over the age of 12 may be permitted to drive tractors, ride on tractors, or ride on implements only where the tractor is being used in connection with agricultural work, and the child —

- Has been fully trained in the safe operation of the tractor and the safe use of any implement that is being drawn by or is attached to the tractor; or
- Is being trained in the safe operation of the tractor and the safe use of any implement that is being drawn by or is attached to the tractor.

3. EMPLOYEE SAFETY

If you are an employer, you should ensure that your employees:

- Have the knowledge and experience, or are supervised by a person with the knowledge and experience, to ensure that the employees and others are not harmed.
- Have been properly trained in:
 - the operation and safe use of machinery and equipment;
 - the correct and safe procedures to follow; and
 - the correct equipment for the task.
- Are aware of the dangers and precautions to be observed.

It's also recommended that you ensure employees are medically and physically fit for the type of work.

Employees must not do anything likely to endanger themselves or others and should report all defects in machinery and equipment to the person in charge.

The duties of employers and employees under the Health and Safety in Employment Act 1992 are explained in more detail in the appendix to this booklet.

4. OVERHEAD POWER LINES

Where overhead power lines cross the farm, consult your local electricity supplier for information on the height and voltage of the lines and the vertical clearance distances required when travelling under or working near the line. Mark this information on the farm map and use it to aid route and work planning.

To ensure you can achieve the clearance distances, you will need to know the maximum height of the machine you are using and the combined height of the machine with its load.

TRAVEL AND WORK UNDER POWER LINES

If you are operating any mechanical equipment such as a loader near the conductors of an overhead line, you must ensure that the equipment or its attached load maintains the minimum distance from the conductor shown in the table* (note that the minimum distance depends on the voltage of the line):

* These requirements are contained in Regulation 82 of the Electricity Regulations 1993 and sections 5.1.1 and 5.1.2 of the *NZ Electrical Code of Practice* (NZECP 34:1993).

MINIMUM DISTANCE BETWEEN CONDUCTORS AND ANY MOBILE PLANT

Line Voltage	Metres
Exceeding 33 kV	4.0
Over 22 kV but not exceeding 33 kV	2.0
Exceeding 650 V but not over 22 kV	1.5
Not exceeding 650 volts	1.0

Any mobile lifting device that is capable of operating within 4 metres of a line must be fitted with an approved warning notice as shown below:

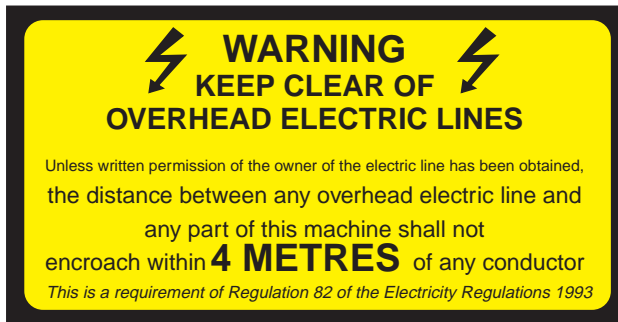

At points of frequent access, consider erecting physical barriers at the appropriate distance from the line, or height-restricting goal posts, to prevent contact with the lines by lifting machinery. Barriers or posts should be placed so that they cannot contact the line in the event of failure. Barriers should be made of wood or other non-conducting material instead of metal pipe or tube because of the risk of contact with the line with conductive parts during erection of the barrier.

BUILDING STACKS NEAR OVERHEAD LINES

Stacks must not be erected under or near the conductor of an overhead line unless the following minimum distances are maintained:

MINIMUM DISTANCE IN ANY DIRECTION FOR CONSTRUCTION OF BUILDINGS, SCAFFOLDING AND OTHER STRUCTURES NEAR CONDUCTORS

Line Voltage	Minimum Distance Under Normal Conditions
Not exceeding 66 kV (maximum span 125 m)	4.0 m
Exceeding 66 kV (maximum span 125 m)	5.0 m
Any voltage (span greater than 125 m but less than 250 m)	6.0 m
Any voltage (span greater than 250 m but less than 500 m)	8.0 m
Any voltage (span exceeding 500 m)	As agreed with the owner of the line but not less than 8.0 m

5. USE THE PROPER EQUIPMENT

Using incorrect equipment for handling bales can be a recipe for disaster.

Use only properly designed and constructed mechanical handling equipment, for example a loader, lift truck or rough terrain handler, with proprietary handling attachment to ensure the bale is secure from movement during lifting. Ensure your machinery is properly maintained.

Examples of the correct equipment to use are shown below. (Photos courtesy Pearson Engineering, diagram courtesy Fairbrother Industries.)

Bale clamp: for handling wrapped and unwrapped big bales



Bale grab: for handling unwrapped big bales.



*Combination
silage and big
bale fork*

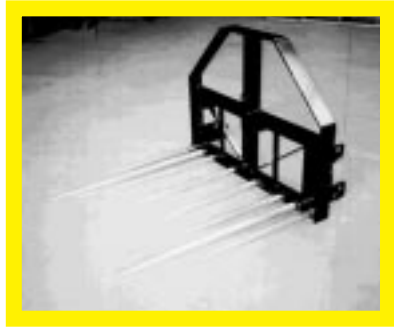

*Bale fork: for
handling big
unwrapped bales.*

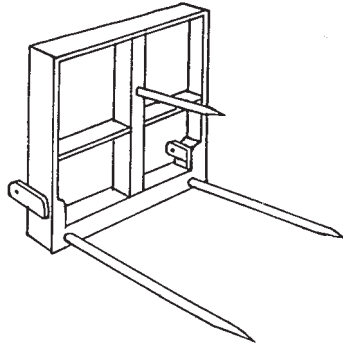

*Left: Bale fork in use.
Below: Bale clamp in use.*

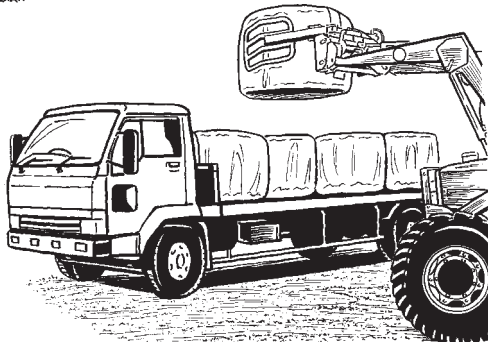
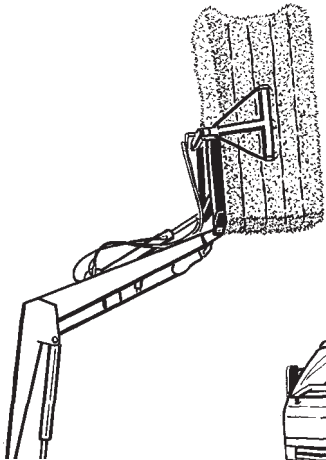

The equipment shown here has been purposely designed to secure the bale or to restrain it so that it cannot fall when raised.

MODIFICATIONS TO EXISTING EQUIPMENT

Existing equipment can be easily modified to prevent bales falling or rolling backwards. An existing round bale fork can be modified by fitting:

- A hydraulic clamp to secure the bale; or
- Horns to the top of the backrest (similar to logging forks) to entrap the bale in the event of the forks being rotated backward while the forks are elevated; or
- A penetration spike mounted in the back of the forks to secure the bale should the forks be elevated and tipped backwards.

It's important to ensure that bale fork mounting pins are compatible with the loader. Sloppy fitting mounting pins can cause the bale forks to flip backwards and dislodge the bale when the loader is extended to full height.

Where possible, avoid using parts and attachments not purpose-built for the particular model of front-end loader you are using. Any modifications made to existing equipment must be purposely designed and the work should be carried out by qualified persons.

HYDRAULIC CONTROLS

Where the existing control valve fitted to the tractor is used to operate the front-end loader, a

recommended safety precaution is to fit a new control valve specifically for the front-end loader. The new valve should be a self-centering, deadman or hold-to-run type control. This will ensure that if the operator's hand is removed from the control valve, the movement of the loader will cease.

The direction of movement of controls should correspond logically to the motion of the moving parts. Controls should also be clearly identifiable and guidance on actuating principles should be provided through appropriate labelling.

6. OTHERS MATTERS TO CHECK

Now for a few other important things to check on your front-end loader, bale handler and trailer.

- Ensure tractor front-end loaders are counterbalanced. Check that axles and tyres are strong enough to cope with the maximum loads imposed on them. Only use tractors with approved cabs or approved safety frames.
- Don't exceed the rated capacity of lifting machinery. Take into account the weight of any load and handling equipment attached. Machinery instruction manuals will provide the relevant information.
- Use trailers which are designed or properly adapted for bale handling. Ensure hooks are fitted so ropes can be used to secure the load. Restraining devices are recommended at both ends of the trailer.
- When travelling on roads or hilly ground, trailer brakes are normally required. Ensure they are maintained and properly connected to the tractor.
- Cover or make safe the spikes on bale handlers when not in use for handling bales. This is particularly important during transport, when the spikes should be covered or folded into a safe position.

- Combustion engine-powered bale elevators are a potential fire hazard. Fit guards to prevent bales and loose material falling onto the engine. Fit sideboards and position the elevator to prevent bales falling and damaging stack edges. Don't use bale elevators as a means of access to and from stacks or loads.

7. TRANSPORTING BALES

Follow these rules when transporting bales on a tractor attachment or trailer:

- Check that the couplings between tractors and trailers are properly secured.
- Do not move partly loaded trailers over slopes or areas of rough ground which could cause bales to be dislodged.
- Determine driving routes over paddocks in advance and instruct drivers accordingly.
- Plan road travel routes to avoid overhead obstructions, such as trees and low bridges.
- When transporting bales by tractor and attachment, carry the bale as low as practicable to the ground.
- Tractor stability may be affected if carrying bales at raised heights over uneven terrain or turning too sharply.
- If stopping to open gates, lower the load to the ground before alighting.
- Ensure people in the vicinity are clear of the driving route during transportation.
- Travel at a safe speed at all times.
- Ensure that no one rides on any machinery, particularly the drawbars of trailer units.

8. SAFE STACKING

It's important to stack bales correctly to avoid creating hazards to yourself and other people.

- Build stacks on firm, level ground away from fire hazards, sources of ignition, overhead power lines, dwellings, boundary fences and footpaths. Ensure stacks are safe at all times. Take precautions to prevent mechanical damage, for example by transport, rodents and undermining by cattle.
- Never stack higher than the lifting capabilities of the handling equipment used for stacking and destacking. This is particularly important if you employ contractors to do the job. Make sure stack and load heights do not exceed the lifting capabilities of your own handling equipment.
- Never stack more bales on handling equipment, to a height higher than the equipment is designed to handle.
- Wherever possible, stack big bales (rectangular, square or high-density) by overlapping to form a stable stack. Big square bales are normally stacked to a maximum of four layers high. High-density bales can be stacked flat up to six layers high.

- Big round bales may be stacked either on their ends, if covered, or on their sides in a pyramid.

End stacking: Use bales of the same diameter (see table over page).

Pyramid stacking: Don't stack more than four layers high. Each bale on the bottom layer may be chocked to enable safe and convenient destacking.

Fit stakes or supports to either side of the stack.

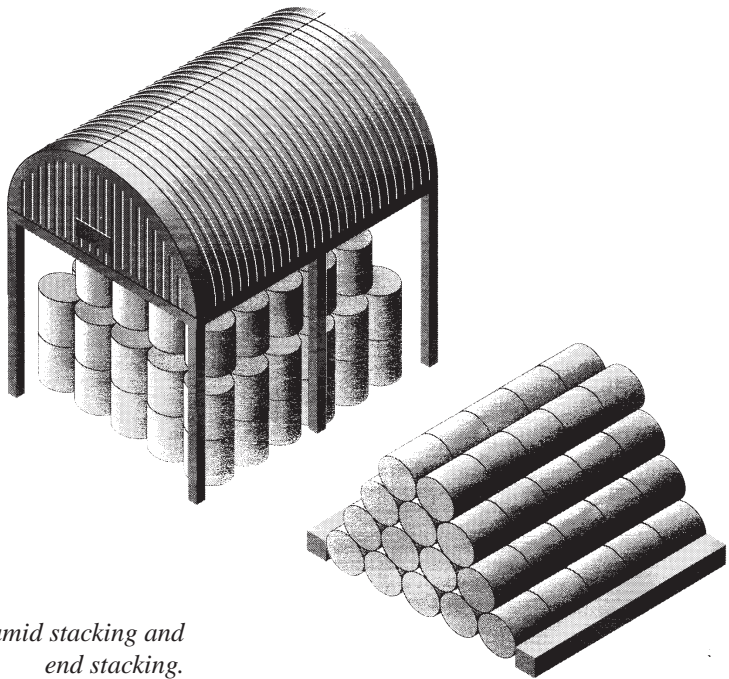

Pyramid stacking and end stacking.

END STACKING: HEIGHT OF STACK

BALE WIDTH: 1.2 m

Note: Maximum stack height is three times bale's diameter.

Bale diameter (m)	0.9	1.2	1.5	1.8
Maximum stack height (number of bales)	2	3	3	4

- Never build a conventional stack of bales higher than the limits of safe access to and from the stack. Height will also be limited by the means used for getting bales from the loads onto the stack. Stacks will be more stable if their height does not exceed 1.5 times the shortest base dimension. Where stacks are likely to be dismantled over a period of time, build them under cover so the stack can be taken down without exposing each layer to the weather.

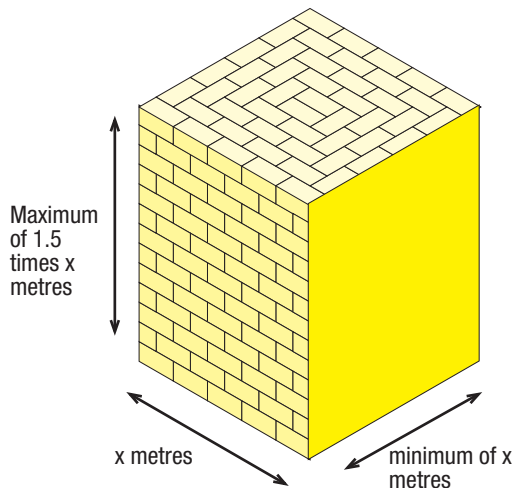

- Where regular access past stacks is unavoidable, either by employees or other people, or where excessive wind loading is likely, do not stack to these maximum heights.
- Large hay bales often weigh about 500 kg and a stack collapsing inside a building could cause damage to its structure, which in turn may injure people. Some structures may not be strong enough to support large hay bales stacked against them. For these reasons, structures for storing large hay bales should be designed, manufactured and built by suitably qualified people who have taken these factors into account.

9. DESTACKING

There are some common sense precautions you should take when removing bales from a stack or load.

- Take care not to dislodge other bales. Always use mechanical handling equipment for big bales, destacking from the top first. Never remove bales from the bottom of the stack to leave overhanging bales unsupported.
- Falls from stacks may occur during destacking. Causes may include trying to free jammed bales, picking up bales with broken strings and falling from edges. When destacking, plan the work to avoid incidents like these. If stacking has been carried out correctly, destacking becomes simpler.
- Remember to use a safe means of access to the stack.

10. MAINTENANCE OF STACKS

Having created a good stable stack, you need to make sure it stays that way.

- Make regular checks on all bale stacks to ensure that the stack is in good condition and not in danger of collapse or bales coming loose.
- Cordon off and/or dismantle stacks which become unsafe, using a safe system of work which takes account of the risk of falling bales.

11. SAFETY WITH TRAILERS

Avoid accidents caused by people being hit by runaway or overturning trailers, falling off trailers, or being hit by falling loads.

- Park trailers in a safe position during loading to ensure the trailer will not run away or overturn. Load in a sequence which ensures that the load is never unstable. Don't exceed the maximum permitted axle and gross weights.
- Load heights will be limited by the method of loading, slopes, overhead obstructions, etc. Normally, overall height should not exceed 4 metres.
- When manually stacking bales, arrange for communication between those on the load and those on the ground, particularly if loading by machine, e.g. sound horn and wait for a response before moving.
- Avoid carrying passengers on trailers. Ensure no one rides on the drawbar of a trailer.
- Ideally, leave the load in one position from start to roping. However, a stacker may travel short distances on a load, provided they are safely positioned and there is no risk of the load collapsing or the stacker falling.

- During loading, bales are often dislodged or dropped. Keep the area around trailers clear unless pitching manually. Take care not to drop bales, but don't put yourself at risk trying to stop them falling.

12. ROPING AND SHEETING

An insecure load on a trailer may cause the trailer to tip over, or injure someone if it falls off.

- Rope or sheet loads before transport.
- Ensure that the securing method used means that the load is stable when the vehicle is braked, accelerated or when cornering.
- Consider also the effects of rough tracks and gateways.
- Remember, roping cannot make an unstable load safe.

13. WORKING AT HEIGHTS

When you are planning handling and stacking systems, think of ways of reducing the risks of people falling. The risks will vary according to the experience of operators, the size of bale, the type of stack and the material being stacked or loaded. The precautions available will depend on where the work is carried out.

- Falls from stacks built in barns or buildings can be prevented by using guard rails on the sides of the buildings through which movement of bales is not in progress.
- In some cases, doors or sides can be fitted to barns.
- Consider marking stack edges, or limiting stack height to reduce the risks. Stacking and destacking in tiers over a number of bays ensures easy access.
- Use a safe means of access to and from working positions above ground level, e.g. proprietary working platforms on material handlers or secured ladders.
- Check that ladders are suitable for the purpose and in good condition.
- Pay particular attention to the binding of stacks and loads. Use well-made solid bales for the edges of the stack. Avoid working at

the extreme of stack edges and always stand clear of handling equipment.

- Don't use the bale elevator as a means of access unless it has been disconnected from its power source.

14. ACCIDENT CASE HISTORIES

The following are some case histories of accidents involving hay bales that have been investigated by Occupational Safety and Health inspectors. All these accidents could have been prevented if the advice given in this booklet had been followed.

DID NOT LOWER LOAD BEFORE ALIGHTING

A farm hand was found pinned dead beneath the lowered front-end forks and a round bale. The bale weighed approximately 400 kg and was impaled on five prongs. Normally, the bales were transported 2.5 metres above ground.

No fault was found in the equipment. The inspector's conclusion is that when the farm hand alighted to open the gate, he may have activated the controls, causing the forks to descend. He had opened the gate with his back to the forks.

To prevent such accidents, the load should be lowered before alighting to open a gate.

EQUIPMENT UNSUITABLE FOR HANDLING BALES

A 49-year-old farmer was seriously injured when a 500-kilo round bale (1.1 m x 1.9 m) that he was raising rolled back onto him.

One end of the bale had been supported on two

forks which had a pipe backrest fitted. This equipment was unsuitable in that the two forks were not adjustable, the bale was not secure on the forks, and the backrest was bent backwards. (The farmer had intended to repair the backrest later.)

As the farmer raised the forks and drove in reverse, trying to avoid a power pole, the bale rolled backwards onto him.

UNFAMILIAR WITH CONTROLS IN EMERGENCY

A 28-year-old truck driver suffered serious injuries when an unrestrained round bale (1.85 m x 1.22 m) fell off the forks on a front-end loader fitted to a tractor and struck him.

The driver was unfamiliar with the tractor front-end loader and was working on his own outside normal working hours.

He had already loaded the first layer of round bales onto the deck of the truck. He picked up a bale which faced forwards on the forks. The rear fork backrest frame was 640 mm high and the bale, sitting on the forks, was 1.85 metres high.

As he approached the truck, he raised the bale some 3 metres high. The bale overbalanced and began falling towards him. He reacted by throwing the spike control lever for the forks forward, intending to decrease the angle of the spike tilt. Instead, his action increased the tilt angle of the bale, which fell towards him.

It was found that the front-end loader hand controls operated in a manner contrary to that

expected. Moving the controls forward to lower the tilt of the forks actually increased the inclination, affecting the bale's centre of gravity and tipping it towards the driver.

In this case, an experienced operator was unfamiliar with the controls in an emergency situation. The controls also operated contrary to the norm. The backrest for the forks was unsuitable for the size of bales being handled. Also, the bale was not secured to prevent movement.

MANUFACTURERS' EQUIPMENT INCOMPATIBLE

A 38-year-old deer farmer died when he was crushed between a round bale and a two-post tractor safety frame. The bale rolled onto him when he raised the forks to clear a 2.4 metre high deer fence while doing a tight U-turn in reverse.

The fork attachment and backrest fitted to the front-end loader were not from the same manufacturer as the front-end loader. The forks were able to be rolled back further than the standard design allowed, causing an unrestrained bale to roll off the forks onto the driver.

The inspector who investigated the fatality found that the use of equipment from different manufacturers was responsible for the tragedy.

All proprietary agricultural equipment is designed to meet specific requirements for a specific job and to work as a unit. In this case, the front-end loader was designed to be used with loader attachments specifically designed for that type of loader.

At the design stage, all perceivable problems are designed out to safeguard the operator. For example, with front-end loaders, maximum crowd angles are controlled by the placement of pivot points and ram stroke choice on the drawing board.

When equipment from different manufacturers is coupled, the design criteria are overridden and designed-in safeguards are often removed or become ineffective.

The use of another manufacturer's bale forks on this particular loader resulted in a tighter crowd angle than was possible with the correct forks. The forks could be rolled back further than the standard design permitted, allowing an unrestrained bale to roll from the fork towards the driver.

KILLED WHILE RIDING TRAILER DRAWBAR

A 16-year-old youth was fatally injured during haymaking. He was riding on the drawbar of a trailer being towed by a truck.

He went to sit down on the drawbar, slipped and fell to the ground and was run over by the trailer wheel. The loaded trailer weighed 5 tonnes and at the time of the accident was travelling at about 3 km an hour.

Both the contractor and the truck driver had warned workers of the dangers in riding on a drawbar. Neither the contractor nor the driver was aware at the time that the accident had occurred.

When found, the victim was flown to a nearby hospital by helicopter but unfortunately he died of his injuries two days later.

The truck and trailer were loaded with three layers of bales, which meant that the driver could not see anyone standing on the drawbar. Despite this, it appeared to be common practice for people to ride on the drawbar.

This accident highlights the significant hazards involved in riding on drawbars and implements.

15. BASIC SAFETY RULES

The safety advice in this booklet can be summed up as follows:

- Assess the risks before you start work.
- Use the correct equipment for the job.
- Don't exceed the rated capacity of the lifting machinery.
- Keep children away from machinery.
- Watch out for overhead power lines.
- Keep load low when travelling.
- Ensure stacks are safe at all times.
- Maintain your machinery and equipment in a safe condition.
- Be aware of the precautions to be observed when destacking.
- Ensure measures are taken to prevent falls from heights.
- Be aware of the risks involved when using trailers.
- Avoid sudden movements, especially when load is raised.
- Look where you are going — be alert.
- Report all defects to the person in charge.

APPENDIX: SUMMARY OF LEGAL OBLIGATIONS UNDER THE HEALTH AND SAFETY IN EMPLOYMENT ACT

This appendix summarises the legal obligations you have under the Health and Safety in Employment Act 1992, whether as an employer, employee or self-employed person.

EMPLOYERS' RESPONSIBILITIES

Employers have a general duty to take all practicable steps to ensure the safety of employees at work. In particular, employers are required to take all practicable steps to:

- Provide and maintain a safe working environment;
- Provide and maintain facilities for the safety and health of employees at work;
- Ensure that machinery and equipment in the place of work is designed, made, set up and maintained to be safe for employees;
- Ensure that working arrangements are not hazardous to employees; and
- Develop procedures for dealing with emergencies that may arise while employees are at work.

Hazard Management

Employers must identify hazards in the place of work (previously existing, new and potential) and regularly review these to see whether hazards are significant and require further action. Significant hazards are hazards which can cause serious harm. Serious harm is described in the First Schedule of the Act. With significant hazards, the employer must do the following:

- Where practicable, the hazard must be eliminated.
- If elimination is not practicable, the hazard must be isolated.
- If it is impracticable to eliminate or isolate the hazard, then the employer must:
 - Ensure that protective clothing is provided, is accessible and is used;
 - Monitor employees' exposure to the hazard;
 - With the employees' informed consent, monitor their health in relation to the hazard;
 - Take all other practicable steps to minimise the hazard.

When an accident or serious harm occurs in the place of work, an employer must investigate the accident to determine if a significant hazard was involved.

Recording and Reporting Serious Harm

All harm that occurs in the place of work must be recorded in the prescribed form in an accident

register. A suitable register for this purpose can be purchased from OSH offices or selected stationers.

Serious harm must be reported to OSH as soon as possible following the occurrence of harm.

Any accident scene where serious harm is involved must not be disturbed without authorisation by an inspector to do so unless it is necessary to:

- Save life or prevent suffering;
- Maintain access for emergency services; or
- Prevent serious damage or loss of property.

Training and Supervision

Employers must ensure that every employee has, or is supervised by a person with, the knowledge and experience to ensure that they and others are not harmed at work. They must also ensure that all employees are adequately trained in the safe use of all plant, machinery, substances, and protective clothing and equipment provided.

Employers must also ensure that employees must be made aware of all hazards they may be exposed to or may create, while at work and provide advice on what to do if an emergency arises while at work.

EMPLOYEE RESPONSIBILITIES

Employees have a responsibility to take all practicable steps to ensure their own safety and the safety of others while at work.

SELF-EMPLOYED RESPONSIBILITIES

Self-employed people also have a responsibility to take all practicable steps to ensure their own safety and the safety of others while at work.

PEOPLE IN CONTROL OF A PLACE OF WORK

People who own, lease, sublease, or occupy a place of work, or who own, lease or sublease plant or equipment, are defined by the Health and Safety in Employment Act 1992 as being in control of the place of work. These people must take all practicable steps to ensure that people in or near the place of work are not harmed by hazards in the place of work by the plant and equipment.

CONTRACTORS AND SUBCONTRACTORS

If you hire a contractor or subcontractor (e.g. a drainage contractor, fencer, shearer, etc) you must take all practicable steps to ensure the contractor, subcontractor and their employees are not harmed while at work.

ALL PRACTICABLE STEPS

Taking all practicable steps means doing what is reasonably able to be done in the circumstances, taking into account:

- The severity of any injury or harm to health that may occur;
- The degree of risk or probability of that injury or harm occurring;

- How much is known about the hazard and the ways of eliminating, reducing or controlling it; and
- The availability, effectiveness and cost of the possible safeguards.