

# HOT WORK

*ON DRUMS & TANKS*



# **CONTENTS**

<b>ABOUT THIS BOOKLET.....</b>	<b>3</b>
<b>1 WHY ACCIDENTS HAPPEN .....</b>	<b>4</b>
<b>2 WHAT TO LOOK OUT FOR .....</b>	<b>6</b>
<b>3 HOW TO CLEAN TANKS AND DRUMS .....</b>	<b>9</b>
<b>4 HOW TO INERT DRUMS AND TANKS .....</b>	<b>20</b>
<b>5 SAFETY HINTS FOR HOT WORK .....</b>	<b>25</b>
<b>6 ALTERNATIVES TO HOT WORK.....</b>	<b>27</b>
<b>7 SUMMARY AND ADDITIONAL REMINDERS .....</b>	<b>29</b>
<b>8 THE EMPLOYER'S RESPONSIBILITIES .....</b>	<b>33</b>
<b>APPENDIX 1: SOME DANGEROUS SUBSTANCES ..</b>	<b>35</b>
<b>APPENDIX 2: ACCIDENT REPORTS .....</b>	<b>38</b>

Published: March 1988

ISBN 0-477-03420-9

# ***ABOUT THIS BOOKLET***

This booklet describes the safety procedures that should be followed by anyone who plans to do hot work — that is, welding, gas cutting, brazing or soldering — on any fuel tank, drum, container or pipe that has previously contained a combustible substance.

If you do this type of work, whether as part of your job or simply as a hobby, it is vital that you understand the dangers involved and faithfully follow the procedures described here.

This booklet is primarily concerned with hot work on tanks, drums and vessels with a capacity of less than 2,500 litres. Some mention is made of the specialised procedures required when working on larger vessels, but no one should attempt this complex and dangerous work without previous training and experience.

Many people have been injured or killed by exploding drums or tanks — few of those cases are reported in Appendix 2 of this booklet. All these accidents have followed a similar pattern and all could have been avoided if the proper precautions had been taken. Don't make the mistake of thinking accidents always happen to someone else.

When you have read this booklet, we suggest you keep it handy in your workshop for future reference. We also suggest you bring it to the attention of your colleagues or friends who do this type of work. A little time spent studying it could prevent a lot of unnecessary suffering.

# ***1 WHY ACCIDENTS HAPPEN***

Any combustible material in a tank, drum or similar container can give off vapour or fumes when you apply heat to it. Mixed with air in the right proportions these fumes can explode violently when the critical temperature is reached or when ignited by a spark from a welding or cutting torch. Sometimes even a spark from a mechanical tool will be enough to ignite highly explosive vapours such as petrol. If a tank or drum explodes while you are working on it, you are likely to suffer multiple injuries:

- The shock wave or blast produced by the rise in pressure may damage your ear drums, lungs and circulatory system.
- Fragments from the vessel become missiles which can cause penetrating and damaging wounds.
- You may be hurled against a wall or hard object and suffer broken bones and further internal injuries.

As you will see from the accident reports (pp.38-39), these injuries may be fatal.

You should realise that even a minute amount of a combustible substance may generate enough vapour to cause an explosion. Sludge or scale deposits in a drum or tank may seem harmless enough but they may well release explosive vapours when the surface is heated.

You should also realise that even if a drum has been empty and exposed to the weather for years, it may still contain hazardous substances in the seams or crevices. Never assume it is safe for hot work – always take the precautions described here.

# **2 WHAT TO LOOK OUT FOR**

You may already know the more obviously dangerous substances – petrol is certainly the commonest. But there are many other substances which are not usually thought of as explosive but which can be under certain circumstances.

Flammable or explosive vapours may be present in a vessel that has held any of the following:

- (a) Any volatile liquid that releases flammable vapour at atmospheric pressure.

Examples: petrol, acetone, white spirit.

- (b) A non-volatile oil or solid that releases flammable vapour when heated (some of these substances undergo thermal cracking).

Examples: diesel oil, tar, greases, linseed oil, tallow, soap.

- (c) An acid that reacts with metals to form hydrogen.

Examples: sulphuric acid, nitric acid, hydrochloric acid.

- (d) A combustible solid, finely divided particles of which may be present in the form of an explosive dust cloud.

Examples: fibreglass, milk powder, sulphur.

There are also many chemical compounds that decompose when heated, forming potentially hazardous vapours. A list of some common industrial chemicals and dusts that pose explosion hazards is given in Appendix 1 of this booklet.

Always try to identify which substance a container has held so that you can take any special precautions needed. Remember, however, that labels do not always correctly indicate the contents, as a container may have been used to store other substances. It is wise to treat the contents of all containers as potentially dangerous and act accordingly.

A special warning must be given to workers who weld pesticide spraying equipment. Many insecticides (see Appendix 1) decompose when subjected to heat, producing highly toxic phosgene gas. Inhaling this gas, which has a sweet hay-like smell in low concentrations, will make you seriously ill.

Before hot work is carried out on spray equipment it must be thoroughly cleaned by steaming, as explained in the following section of this booklet.

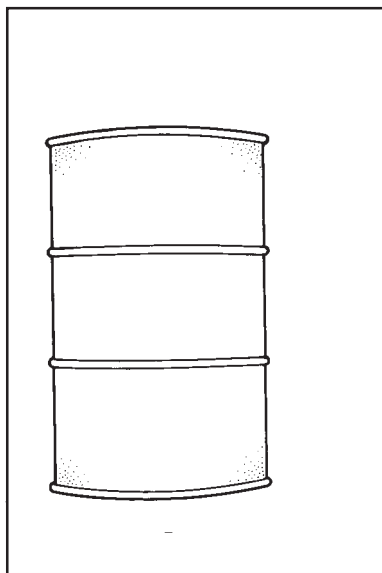

*Traces of substance in seams of drum . . .*

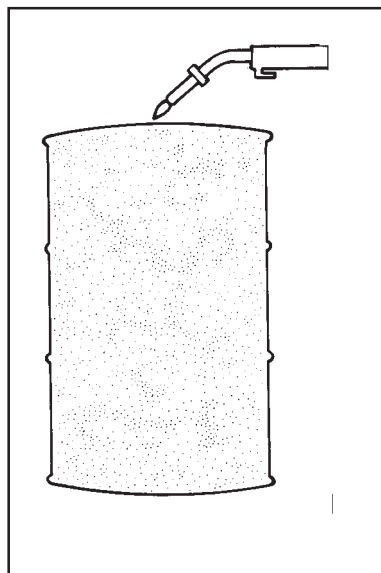

*Volatilise when heat is applied*

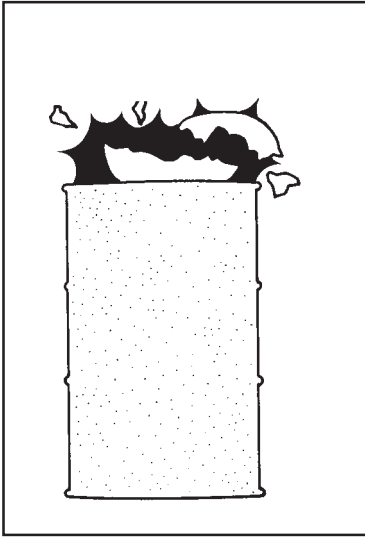

*Explosive concentration is reached and vapour ignites*

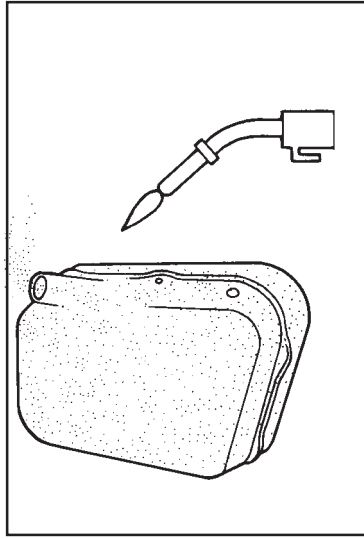

*Petrol tank contains flammable vapours at normal temperatures*

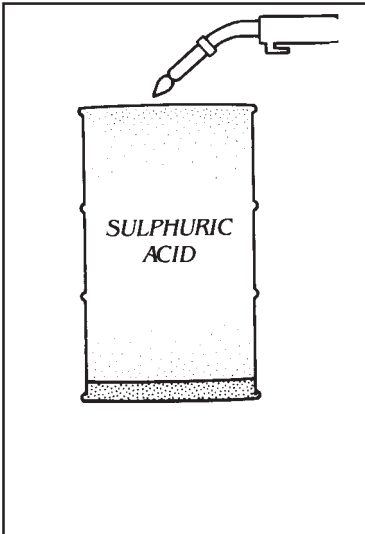

*Acids may react with the metals in containers, producing highly explosive hydrogen gas*

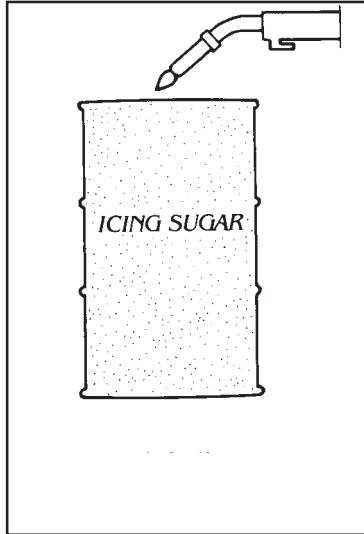

*Mixed with air in the right proportions, many dusts will explode when ignited*

# ***3 HOW TO CLEAN TANKS AND DRUMS***

There are three important points to remember:

- (a) Use only the cleaning methods described here. If the substance is soluble, use the washing method. For non-soluble substances, use either the boiling or steaming method. Other cleaning methods may be recommended but you need some expertise to know whether they are effective for particular substances. Your safety may be at risk if you use a different method from the ones in this booklet.
- (b) Cleaning must be thorough. Don't try to take shortcuts — it's your safety that's at stake. If the cleaning must be done by someone else, it is in your interest to ensure that the person is fully aware of the hazards and the precautions to be taken. An untrained person must be supervised by someone with knowledge of, and experience in, the work. If contractors are engaged, you should ensure they are suitably qualified for the work.
- (c) You must check for the presence of residues in the tank or drum after carrying out the cleaning procedures. If residues are present, you must take the additional steps described here before you begin hot work.

## **PREPARATORY STEPS**

If you are going to work on a vehicle fuel tank, it

must be thoroughly drained of oil and petrol and removed from the vehicle. Make sure there are no ignition sources present (e.g. lighted cigarettes, spark-producing electric motors). Never drain a petrol tank over a pit or depression in the ground. If you are working on a drum or similar container, all caps, bungs or lids must be removed. If you have to use tools to do so, make sure they are a nonsparking type (e.g. those made of bronze). Dispose of all residues carefully. If the container has held a corrosive substance, wear rubber or PVC gloves and a face shield or goggles to protect your eyes from splashes.

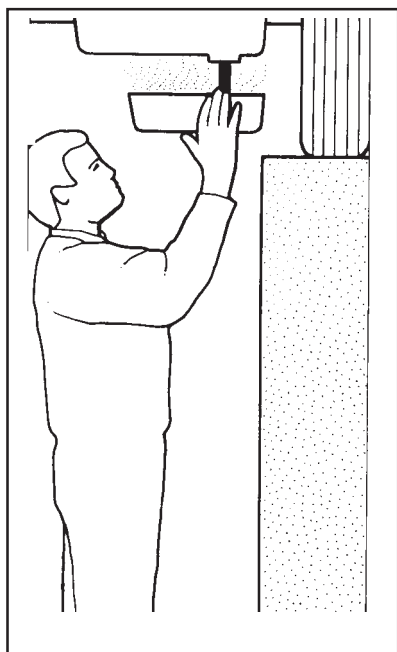

*Do not empty fuel tanks over pits or holes in the ground*

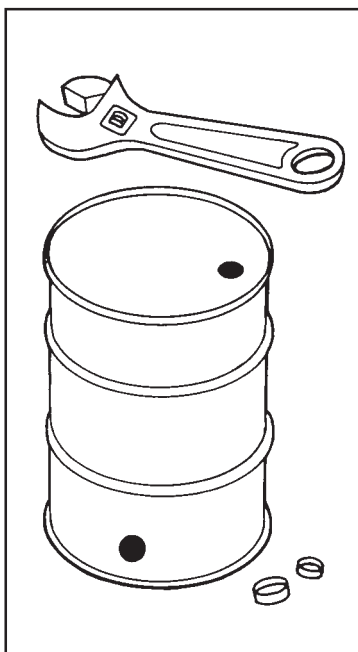

*Remove bungs, tops, etc. before cleaning*

## **WASHING WITH WATER**

Fill the container with water and drain it, repeating several times. This method is suitable only for water-soluble substances. It is particularly suitable for acids such as hydrochloric or sulphuric acid as it eliminates the hazard of hydrogen produced by the reaction of acid on metal.

Washing will not remove petrol, oil, grease and many other potentially hazardous substances (refer to the list in Appendix 1 to see whether washing is appropriate). It is not recommended for any container that has held a solvent, whether combustible or not. For these substances, you must use either the boiling or steaming methods.

Whenever you are unsure about the effectiveness of washing, or you cannot positively identify the substance, always boil or steam the container.

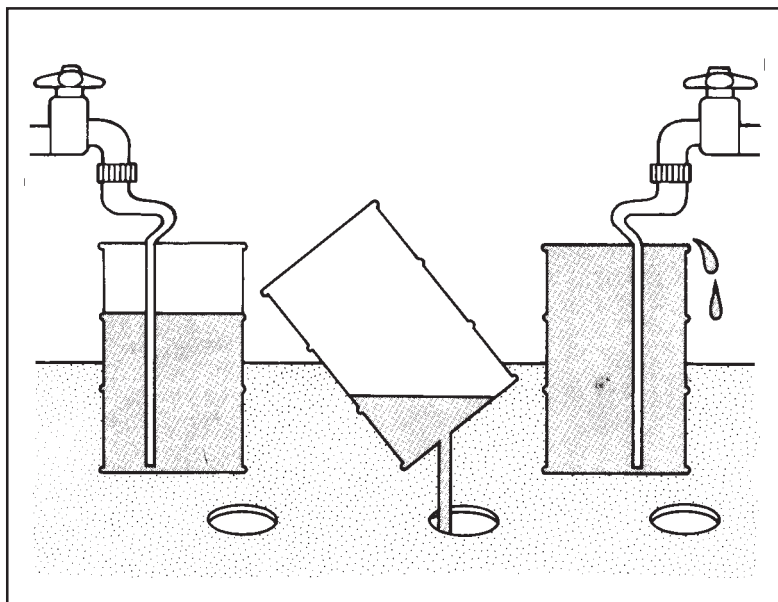

*Washing with water is suitable only for soluble substances*

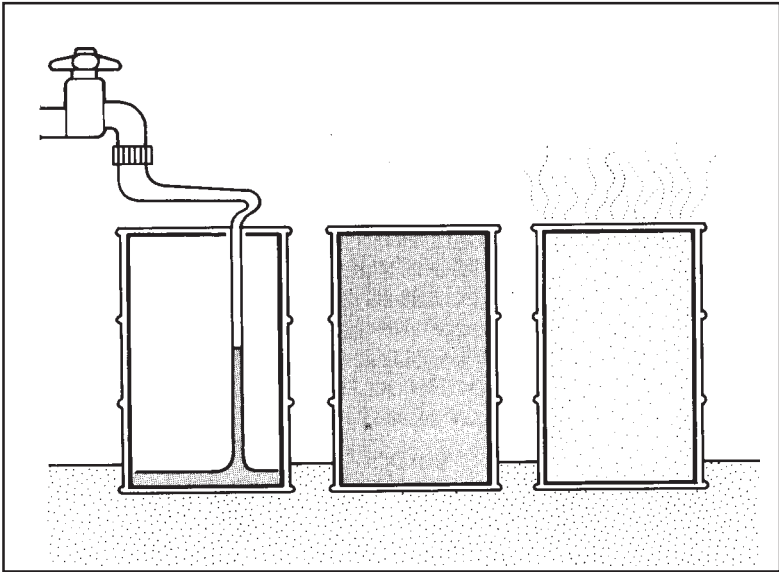

*Washing will not remove oils, greases and many organic compounds*

## **BOILING**

You will need a vat or tank which can be maintained at boiling temperature for at least half an hour. Usually a longer period of boiling is required and the tank must be selected accordingly.

The item to be cleaned must be completely immersed in the boiling water so that the water fills as well as surrounds it. It is essential to add a proprietary degreasing detergent (not a household detergent) to the water, particularly if the tank has held petrol, paraffin, diesel oil or grease.

Commercially available products usually contain substances such as sodium metasilicate, sodium hydroxide (caustic soda) or sodium carbonate (washing soda) and emulsifying agents.

Strong alkalis such as caustic soda will attack aluminium and its alloys, producing hydrogen. If you have to treat such a container, make sure you use one of the weaker alkaline cleansers. You should wear overalls, a PVC apron and gloves and safety glasses or a face shield to avoid getting splashes of strong alkaline cleansers on your skin or in your eyes.

You will need fabric or leather gloves when you are handling containers that have been steamed or boiled as the metal becomes very hot.

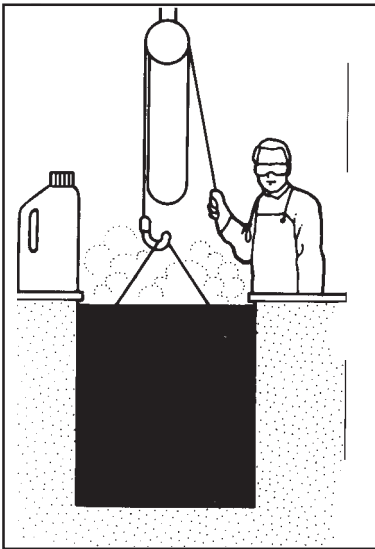

*Drum or tank should be completely immersed in boiling water, with an industrial detergent added, and boiled for at least half an hour*

## STEAMING

Steaming volatilises oils and greases and is particularly suitable for tanks or drums which have held these substances.

You must have a suitable source of low-pressure steam. Make sure there is an outlet for the steam so that pressure does not build up and condensates and sludge can drain away. If there is only one opening, place the tank or drum with the opening downwards so that condensate can escape.

The time required for steaming varies considerably. As a minimum, you should allow 30 minutes of continuous steaming after every part of the item has become too hot to touch. Steaming for less than 30 minutes is likely to be inadequate. Check the condensate at regular intervals. If contaminated with oil or other material it indicates that cleansing is still incomplete. Some items may need to be steamed for 2-3 hours.

If you are steaming a large tank which has held a highly flammable substance, you will need to take precautions to prevent the accumulation of static electricity. The tank and steam pipe should be earthed and the steam pipe should be electrically bonded to the tank.

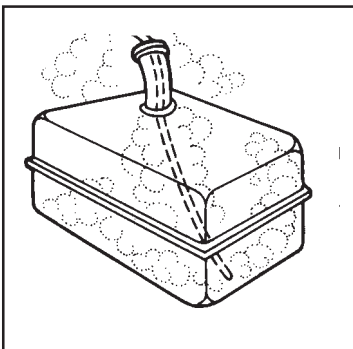

*Steaming is particularly suitable for tanks or drums which have held oil or grease. Allow at least 30 minutes of steaming after the metal has become too hot to touch*

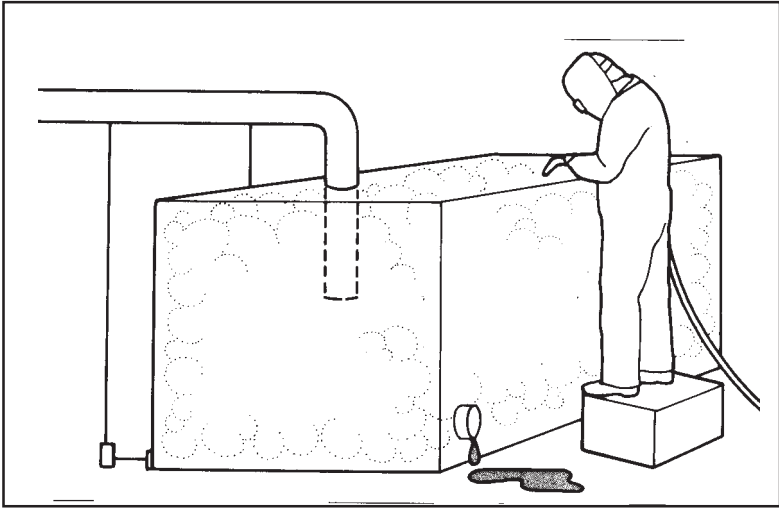

*When steaming a large tank, the tank and steam pipe should be earthed, and the steam pipe should be electrically bonded to the tank*

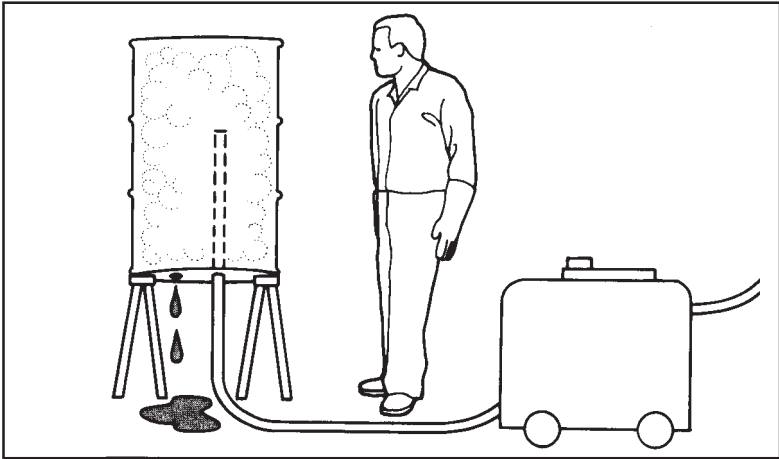

*Drums should be inverted so that condensate and sludge can drain out*

## **CHECKING AFTER CLEANING**

After cleaning, the inside of the container must be checked for residual vapours or solids. Specially designed can or barrel safety torches are available and may be used for visual inspection. Make sure, however, that the equipment is safe for use in flammable atmospheres.

An instrument known as an explosimeter can be used to check for flammable vapours, but the absence of a reading does *not* necessarily mean that a tank or drum is safe to weld. This is because the meter only checks the vapour at atmospheric temperature. During welding, surfaces become very hot and any oil or grease present will be vaporised, forming an explosive atmosphere.

If cleaning has been thorough and you can detect no trace of solid residues or vapours by sight or smell, the item can be considered safe for hot work. To be absolutely sure, you should replace the air in the vessel by water, steam or an inert gas — this is explained in the next section of the booklet.

If flammable vapours or sludge deposits are detected in the vessel after cleaning, you must repeat the cleaning or make sure the vessel is inerted before you carry out hot work. You can also use either trichloroethylene or 1.1.1. trichloroethane to wash out stubborn oil sludge deposits but these substances have a narcotic effect and must be used with caution and only in well-ventilated areas. If you use this method it must be followed by a further cycle of steaming, because of the possible fire or toxic hazards.

If there is a batch of containers to be worked on and someone else is doing the cleaning, it is a

wise precaution to have a second, experienced person examine each one and certify it as safe for hot work.

The Dangerous Goods Act and Regulations require tanks that have held certain classes of dangerous goods to be tested and certified as gas-free by a competent person before hot work is carried out on them.

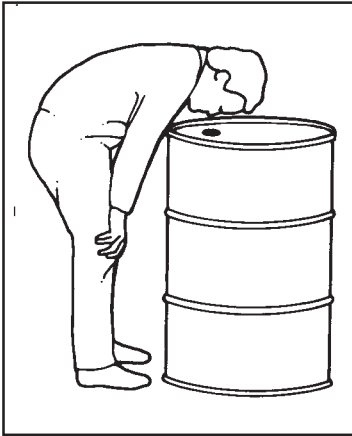

*If you can still smell the substance, the steaming or washing should be repeated*

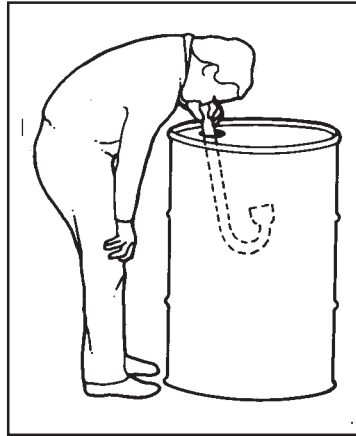

*A can or barrel inspection torch will help you check for solid residues*

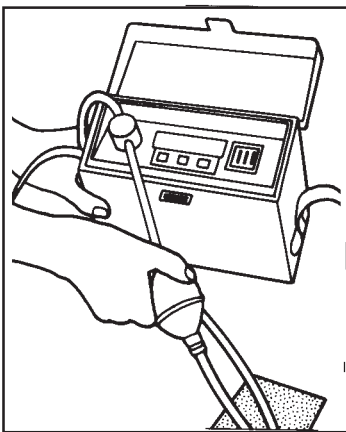

*The explosimeter tests for flammable atmospheres — but you should be aware of its limitations*

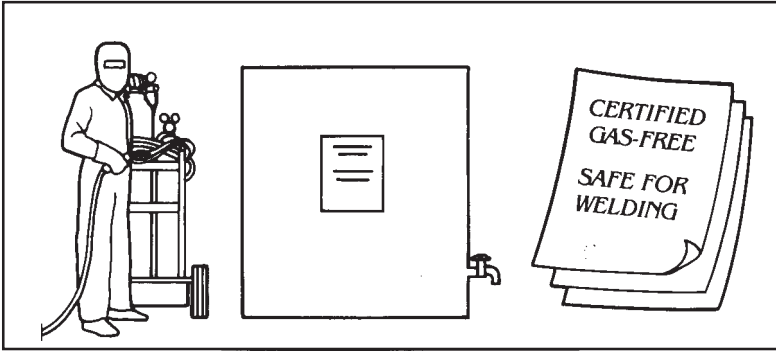

*Tanks which have held certain classes of dangerous goods must be tested and certified as gas-free before hot work is carried out on them*

### **CLEANING METHODS NOT TO BE USED**

The following methods are *not* recommended for removing flammable materials from a tank, drum or similar vessel.

- (a) Blowing out with compressed air. This may remove volatile liquids which produce fumes but will not remove solids or other deposits capable of producing fumes.
- (b) Cleansing with trichloroethylene or 1.1.1 trichloroethane — except as indicated earlier. These are good solvents for removing many flammable substances but there are others they will not remove. They must be used with great care.
- (c) Cleansing with carbon tetrachloride. This solvent is inherently toxic and may form poisonous phosgene gas when heat is applied. It may also react with the metal of the tank or drum. Carbon tetrachloride has proved an ineffective cleansing agent on a number of occasions and explosions have followed.

# ***4 HOW TO INERT DRUMS AND TANKS***

Sometimes it is not possible to remove all combustible material from a vessel. In this case it is necessary to ensure that the material is made non-explosive and non-flammable. The method normally used is to replace the air in the vessel with water or an inert gas.

You may also use one of the inerting methods described below as an additional safeguard after cleaning.

## **FILLING WITH WATER**

This is the easiest method for most vehicle fuel tanks and drums.

If you are using electric welding gear to make a repair, you can replace the air by completely filling the vessel with water. You should fit a vent to relieve any pressure generated by steam.

If you are making a repair by oxy-acetylene welding, brazing or soldering near an opening in the vessel, fill the vessel with water, leaving a small free air space at the point where the repair is to be made. Remember, the vessel must be cleaned as thoroughly as possible beforehand.

This is a very useful technique when you have to repair a joint between a short filling pipe and a fuel tank.

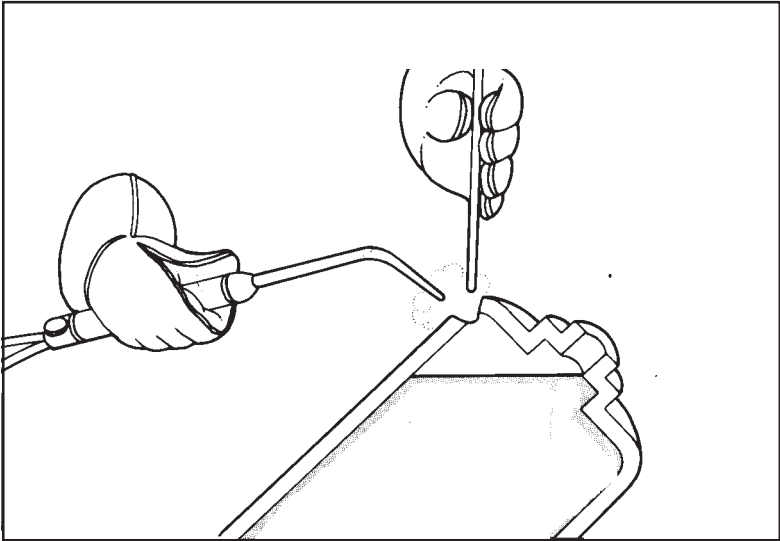

*If gas welding, fill the tank or drum with water up to the point where the welding is being performed*

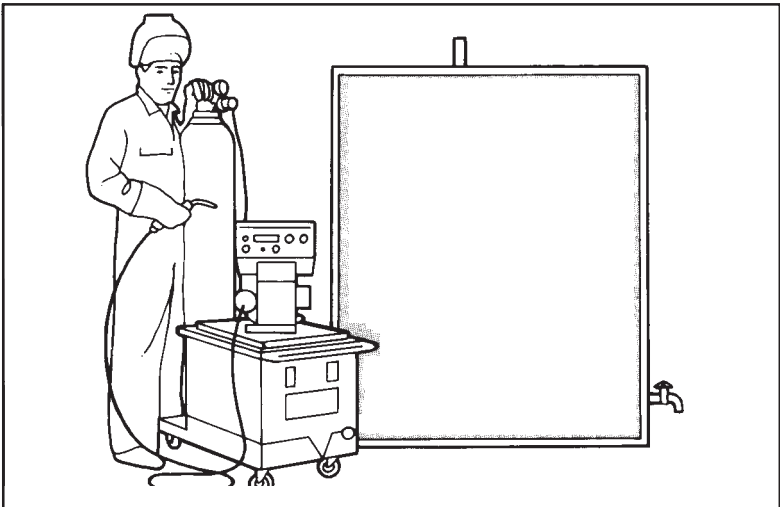

*If electric arc welding, fill the tank completely with water — but keep welding gear dry*

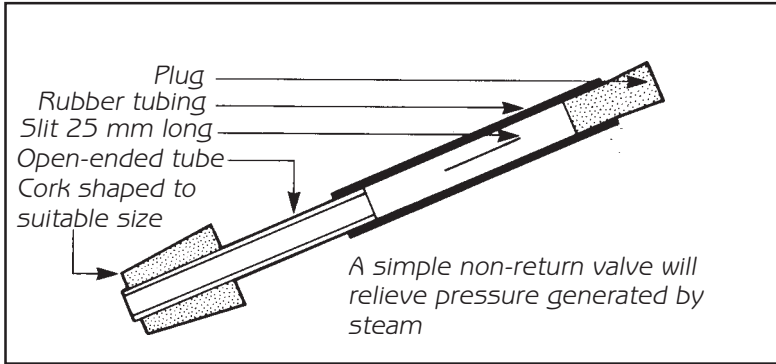

## **CONTINUOUS STEAMING**

The procedure is basically the same as for steam cleaning except that you allow steam to continue flowing through the tank during the welding operation. You should use a stand pipe, if necessary, to make sure the steam flows the full length of the tank.

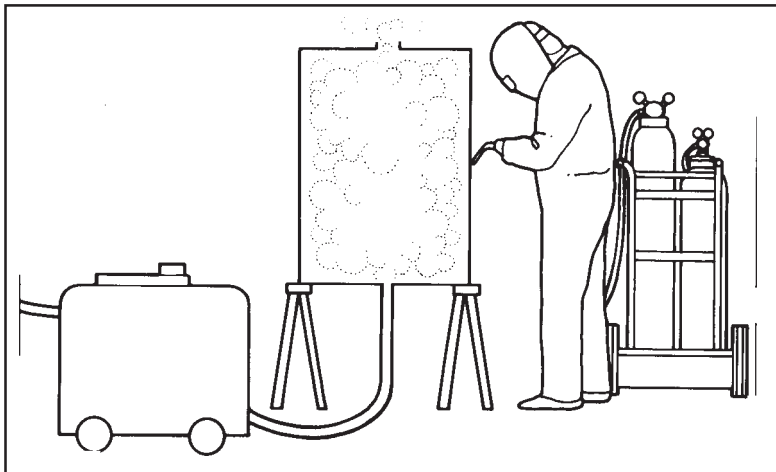

*In the continuous steaming method, steam flows through the tank while the welding or cutting is being carried out*

## **FILLING WITH CARBON DIOXIDE**

A heavier than air gas, carbon dioxide does not support combustion and may be used to inert a tank when it is not practicable to fill it with water. You need to ensure that all the air in the tank is displaced and that the carbon dioxide does not leak from an exit point at the bottom of the tank. To prevent excessive loss of carbon dioxide or the buildup of pressure, the filling opening should be fitted with a simple non-return valve.

Carbon dioxide is supplied as a bottled gas in liquid form. If the cylinder is inverted with the valve open, the gas freezes into solid snow-like pellets known as 'dry ice'. These gradually vaporise back into a gas — there is no liquid form of carbon dioxide at atmospheric pressure.

As a general guide you should add at least 0.5 kg of dry ice per 250 litre of tank capacity to ensure the tank is completely filled.

Dry ice is very cold and should only be handled with gloves or tongs.

*Note: This method is only suitable for small tanks — up to about 1,000 litres in capacity. In larger tanks the CO<sub>2</sub> gas will be so cold and heavy that only the atmosphere at the bottom of the tank will be inerted.*

## **FILLING WITH NITROGEN**

Nitrogen is used to inert the atmosphere inside large tanks — for example in the oil industry — but this is a specialised application. *Its use is only recommended* for people with the necessary expertise.

Nitrogen is slightly lighter than air and tends to rise. When this method is used, it is essential to ensure

that the tank is completely filled with the gas. A light flow of gas must be maintained throughout the welding operation and any breaks in between. It must be stressed that while carbon dioxide and nitrogen are not toxic, neither gas will support life. No one should enter a tank containing either gas without breathing apparatus. The area in the vicinity must be provided with good natural or mechanical ventilation.

# ***5 SAFETY HINTS FOR HOT WORK***

It is assumed in this booklet that you are already familiar with the correct procedures for welding, brazing or gas cutting. If you are in any doubt, you should obtain a copy of the Occupational Safety & Health booklet *Welding Safety*.

Here are the main safety rules to observe:

## **CLOTHING**

- Always wear industrial overalls and eye protection during welding and cutting work. Keep overalls fastened up to your neck and round your wrists.
- Wear safety footwear if you are handling heavy drums or tanks.

Wear gloves or gauntlets while arc welding to protect against shock, burns and radiation burns.

## **EQUIPMENT**

- Make sure all equipment is in good order.
- Make sure flashback arrestors are fitted to gas welding gear.
- Beware of leaking hoses and connections which are not gas-tight.
- Check insulation of all cables on electric arc welding gear.
- Do not arc weld in wet conditions.
- Use an isolating transformer with all portable electrical equipment.

- Make sure welding screens are erected to protect others from ultraviolet radiation.

## **VENTILATION**

- Make sure your work area is well ventilated. The ultraviolet light from welding converts oxygen in the air around you to ozone, which initiates the lungs. There are also toxic substances in fluxes, filler rods, coatings and cleaning agents. Other poisonous fumes are produced by welding or cutting metal coated with paint, resin or varnish.

## **BURNS**

- Always cool down hot metal or mark it with chalk if there is a chance someone could accidentally touch it.

## **FIRE PREVENTION**

- Keep a fire extinguisher handy, particularly when working on containers with a coating of flammable material such as paint.
- Keep the work area free of flammable liquids and wastes or piles of rubbish in which sparks could smoulder.

# 6 ALTERNATIVES TO HOT WORK

One way to avoid the dangers associated with hot work on drums and tanks is to consider alternative methods not involving heat.

Mechanical drum opening tools are an excellent alternative to gas cutting. Resembling large tin snips, they remove the tops from drums quickly, efficiently and without risk to the operator.

Because they cut close to the inside of the drum, they leave no dangerous jagged edges.

As an added precaution, particularly if the drum has held a highly flammable solvent, you should fill the drum with water first.

For repairing small holes, proprietary compounds of the 'cold solder' type may be a suitable alternative to soldering or brazing.

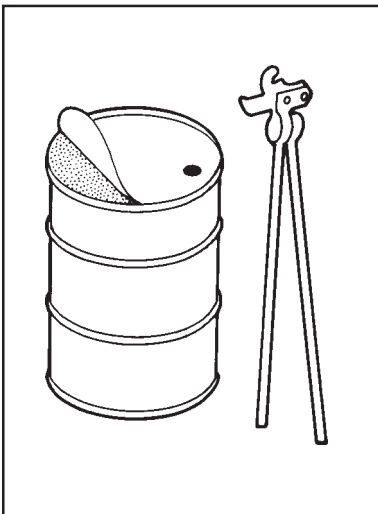

*A drum opening tool avoids the need for hot work. A highly recommended item*

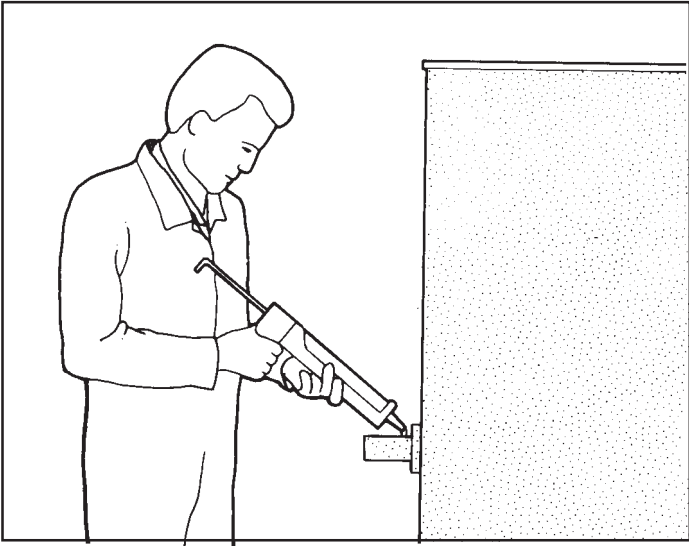

*Proprietary compounds such as "cold solder" may be an alternative to soldering or brazing*

# **7 SUMMARY AND ADDITIONAL REMINDERS**

The message of this booklet can be summarised as follows:

- Severe explosions and fires may occur when welding, cutting, brazing or soldering is carried out on fuel tanks, drums and similar vessels that have previously held flammable materials.
- Many substances not usually thought of as explosive or flammable may be dangerous.
- The only way for hot work to be done safely is for the vessel to be thoroughly cleaned by washing, boiling or steaming as appropriate and the interior carefully checked for residual traces of the substance.
- As an additional precaution, the tank should be inerted by filling it with water, steam or an inert gas.
- Hot work has its own set of hazards. Make sure you know and follow the safety rules at all times.
- Always wear and use the protective clothing and equipment appropriate to the task.
- Avoid hot work on potentially dangerous drums wherever possible, e.g. by using mechanical tools.

Here are some additional safety reminders:

- If one compartment of a two-compartment tank has to be repaired or cut, both compartments need to be made safe. The common example is a tractor fuel tank, which contains a main compartment for oil and a small one for petrol.
- Never use an empty drum, tank or container as a work platform or as a support for hot work. The torch flame or sparks may ignite vapours or solid residues inside it. Either use a proper support or clean the container first as described in this booklet.
- As well as the explosion risks described here, you should also remember the risk of fires. A sudden spurt of flames from filler pipes or other openings can obviously be dangerous. Another danger is that burning material, e.g. flammable liquids may be sprayed on to the clothing of people nearby.
- Never enter a tank or vat to carry out cleaning or hot work. Any work in confined spaces is extremely dangerous and should not be attempted by inexperienced people. The special precautions necessary are outside the scope of this booklet but information is available from OSH offices.

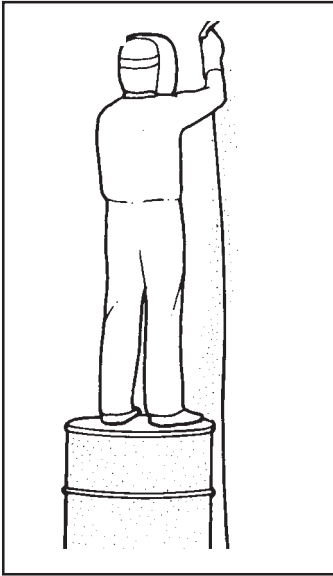

*Don't use a drum as a work platform unless it has first been cleaned*

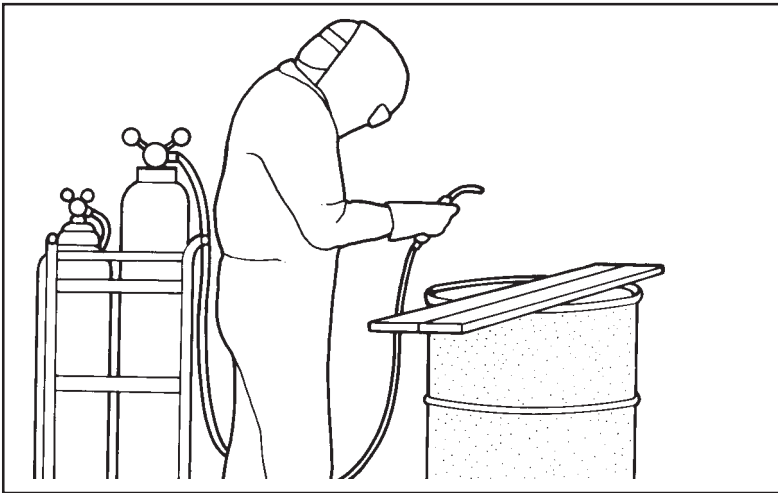

*Similarly, don't use it as a support for hot work*

*Summary of Procedures Prior to Beginning Hot Work on Drums and Tanks*

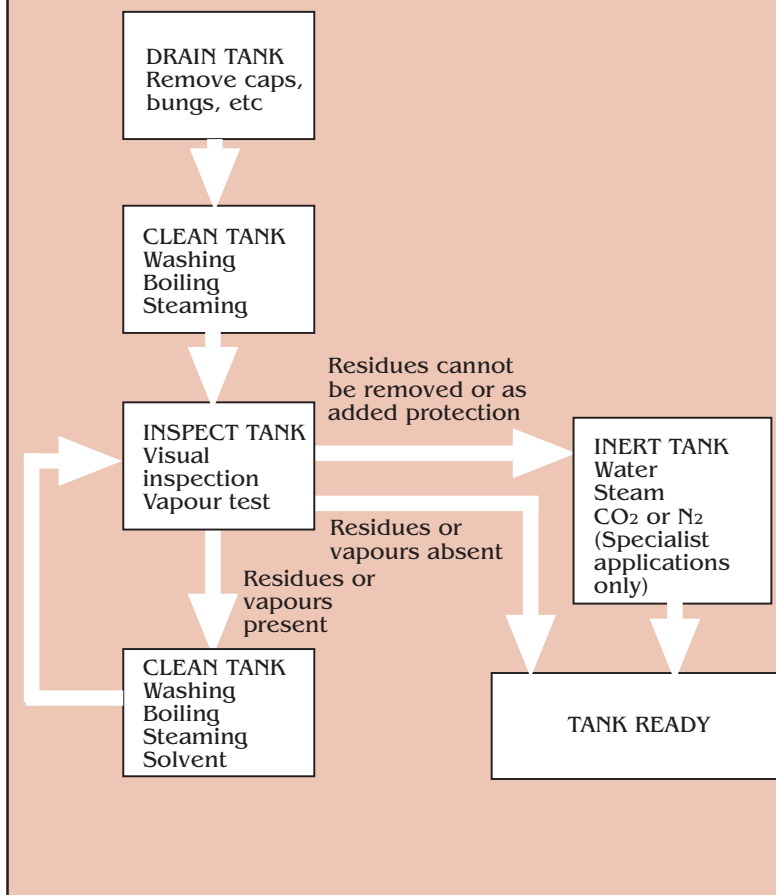

# ***8 THE EMPLOYER'S RESPONSIBILITIES***

Employers are reminded of their legal responsibilities towards workers who are required to carry out the cleaning of tanks, drums, vats, or similar vessels prior to hot work, or to perform hot work on such vessels.

- Workers must not carry out this work unless they have been adequately instructed as to the dangers likely to arise and the precautions to be taken. Where necessary, the worker must be adequately supervised by a person with sufficient knowledge of and expertise in the work.
- All workers must be provided with the necessary protective clothing and equipment, including eye protection, gloves, suitable footwear, overalls and aprons if appropriate. Workers have an obligation to wear and use these items.
- First aid facilities must be provided and be readily accessible to workers. First aid kits should be suitably stocked to deal with the types of injuries possible in this work, i.e. burns, scalds, chemical splashes, eye injuries, cuts and abrasions.

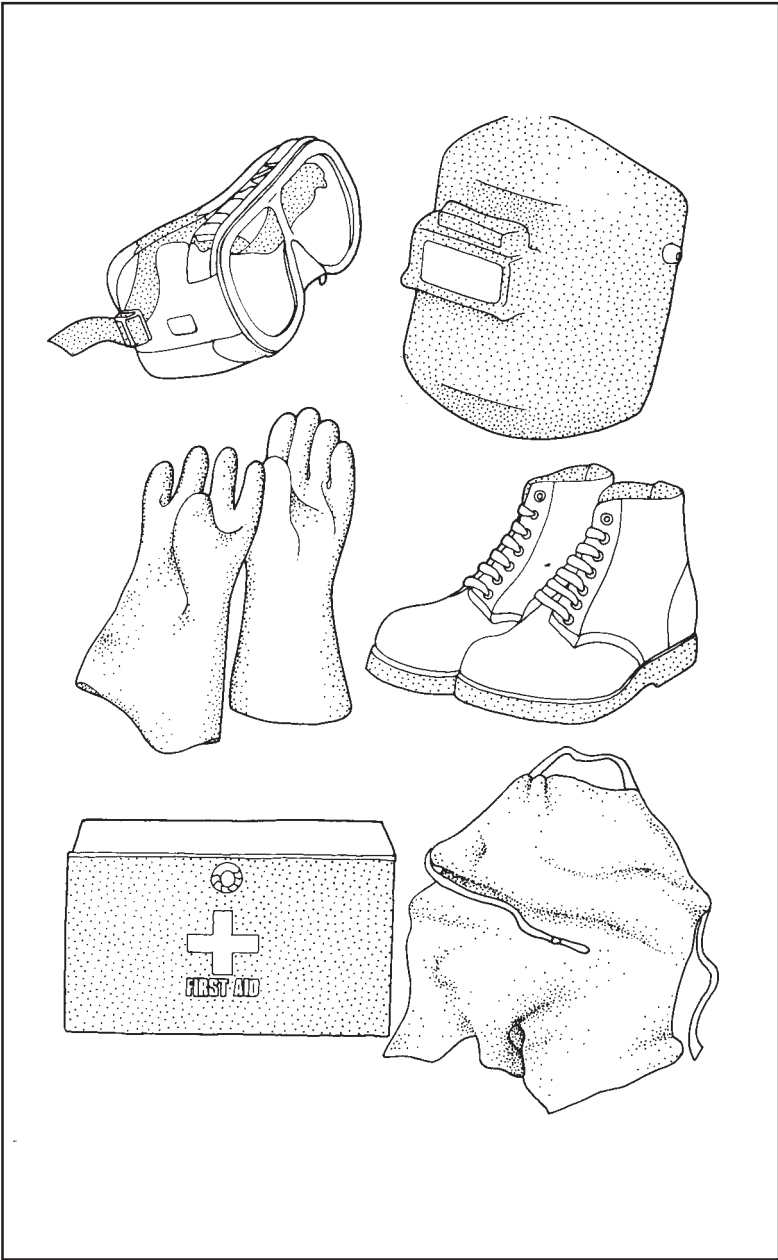

*Employers must supply protective clothing and equipment and workers must use it*

# ***APPENDIX 1: SOME DANGEROUS SUBSTANCES***

The following is a brief list of common industrial chemicals which may be stored in drums and tanks and which pose fire, explosion or other hazards to people carrying out hot work.

The list is not complete and you are urged to treat all chemicals as potentially dangerous.

Substances marked with an asterisk are soluble in water and may be removed by washing with water.

If you are washing out substances such as cyanide, take care in disposing of the wastes. Do not allow them to enter normal water drains. All such waste must be disposed of in accordance with local bylaws.

## **CHEMICALS**

Acetone

Acrylonitrile

Amyl acetate

Amyl alcohol

Ammonia and compounds

Calcium hypochlorite Carbon disulphide

Chlorates and perchlorates of sodium, potassium and ammonium

Chloroform

Cyanides  
Dichloromethane  
Formaldehyde  
Glycol ethers and glycol ether acetates  
Hydrochloric acid  
Isopropyl alcohol  
Kerosene  
Methyl alcohol  
Methyl ethyl ketone  
Mineral turpentine  
Nitric acid  
Phenol  
Hydrocarbon solvents (e.g. pentane, hexane  
heptane, octane)  
Sodium hypochlorite  
Styrene  
Sulphuric acid  
1.1.1. Trichloroethane  
Toluene  
Turpentine  
White spirit  
Xylene

## **EXPLOSIVE DUSTS**

The following is a list of dusts which present a strong to severe explosion hazard. Again it is not a comprehensive list, and it is wise to treat all dusts as potentially explosive.

Aluminium/resin mix  
Barley/maize/lucerne mix  
Cardboard  
Casein

Coal  
Cocoa  
Cornflour  
Cotton waste  
Flour  
Icing sugar  
Leather  
Milk powder  
Paper/wood/resin mix  
Plastic powder  
Resin  
Spice mixes  
Stock feed  
Sulphur  
Wheat  
Wood

## **INSECTICIDES**

The following are common members of the organochlorine group of insecticides. These produce highly toxic phosgene gas when subjected to heat.

Aldrin  
Dieldrin  
DDT  
Benzene hexachloride (BHC)  
Chlordane  
Lindane  
Methoxychlor

# ***APPENDIX 2: ACCIDENT REPORTS***

The Department of Labour investigated, over a typical 6-month period, accidents where hot work had been undertaken on containers holding flammable or combustible materials. Brief details of those accidents are given below:

- An engineer was killed when a 6000-litre tank exploded when he lit a welding torch to repair a seam in the tank. The tank was moved 30 metres in the explosion, and an observer who was standing 2 metres away was thrown to the ground by the blast. The tank had been flushed with water for three days prior to the explosion but this did not remove all the explosive substances.
- A worker was attempting to remove the lid of a 200-litre container that had previously contained lacquer thinners. The drum, which had both bungs in place when the worker applied heat to the lid, hit the roof of the building 6 metres up. The worker received bruising to his hand.
- While removing a cleaning bung from a 70-litre stainless steel boat fuel tank, a worker passed a heated soldering iron over the bung hole. The petrol fumes ignited, throwing the worker on the floor.
- A worker, who had a few moments spare time,

began cutting a 200-litre drum to make a barbecue. He was unaware of the contents of the drum, which exploded when the torch began the cut. He received minor injuries in the incident.

- A worker passed a gas torch to his colleague over the open lid of a bitumen tank, causing an explosion. The worker, who was on top of the tank, received 10% burns to his face and left hand and his leg was broken in three places. The worker on the other side of the tank escaped injury.
- A welding contractor was attempting to fit a tap into a 5000 litre tank. A cut had been started in one end of the tank when it exploded. The tank was turned around and flipped over. The opposite end of the tank was blown approximately 42 metres, soaring over a stand of trees 12 metres high and landing in a vacant section. The contractor received cracked ribs, a dislocated shoulder, injuries to his collar bone and severe bruising all over the body.

There has been no let-up in accidents and many more examples could be given. Remember, all accidents of this type are potentially fatal. Don't let it happen to you!